



PROFINET Network Adapter GN-9587

User Manual



Version 1.0

CREVIS co.,LTD

DOCUMENT CHANGE SUMMARY				
REV	PAGE	REMARKS	DATE	EDITOR
1.00	New Document		2020/07/13	JY HYUN

CONTENTS

1. Important Notes	5
1.1.Safety Instruction	5
1.1.1.Symbols	6
1.1.2.Safety Notes	6
1.1.3.Certification	6
2. Environment Specification	7
3. GN-9587(PROFINET Network Adapter)	8
3.1. GN-9587 Specification	8
3.2. GN-9587 Wiring Diagram	10
3.3. GN-9587 LED Indicator	11
3.3.1. LED Indicator	11
3.3.2. MOD(Module Status LED)	11
3.3.3. NET(Network Status LED)	11
3.3.4. DIA(Diagnostic Status LED)	12
3.3.5. IOS LED(Expansion Module Status LED)	12
3.3.6. Field Power, System Power LED	12
3.4. GN-9587 Electrical Interface	13
3.4.1. PROFINET Connector	13
3.4.2. Dip Switch	13
3.4.3. RS232 Port for MODBUS/RTU, Touch Panel or IOGuide	14
4. I/O Process Image Map	14
4.1. Mapping Data into Image Tabel	15
4.1.1. Discretie Input Module	15
4.1.2. Discretie Output Module	16
4.1.3. Analog Input Module	17
4.1.4. Analog Output Module	18
4.2. Example of Input Process Image (Input Register) Map	19
4.3. Example of Output Process Image (Output Register) Map	20
4.4. MODBUS Special Register Map	21
4.4.1. Adapter Identification Special Register (0x1000,4096)	21

4.4.2. Other Time Special Register (0x1028,4136).....	21
4.4.3. Adapter IP/MAC Address Special Register (0x1050,4176).....	21
4.4.4. Adapter Information Special Register (0x1100,4352).....	22
4.4.5. Expansion Slot Information Special Register (0x2000,8192).....	23
5. MODBUS Reference.....	24
6. Dimension.....	25
6.1. GN-9587.....	25
7. Mechanical Set Up.....	26
7.1. Total Expansion.....	26
7.2. Plugging and Rmoval of the Components.....	26
7.3. Internal G-Bus/Field Power Contacts.....	27
8. Parameter.....	28
7.1. GN-9587.....	28
7.2. GN-9587 PROFINET IO Characteristics.....	28
7.3. Device Access Point.....	28
7.4. Sub-slot of GN-9587.....	29
9. Trouble Shooting.....	30
9.1.How to diagnose by LED indicator.....	30
APPENDIX A.....	32
A.1. Product List.....	32
A.2. Glossary.....	34

1. Important Notes

Solid state equipment has operational characteristics differing from those of electromechanical equipment. Safety Guidelines for the Application, Installation and Maintenance of Solid State Controls describes some important differences between solid state equipment and hard-wired electromechanical devices.

Because of this difference, and also because of the wide variety of uses for solid state equipment, all persons responsible for applying this equipment must satisfy themselves that each intended application of this equipment is acceptable.

In no event will CREVIS be responsible or liable for indirect or consequential damages resulting from the use or application of this equipment.

The examples and diagrams in this manual are included solely for illustrative purposes. Because of the many variables and requirements associated with any particular installation, CREVIS cannot assume responsibility or liability for actual use based on the examples and diagrams.

Warning!

✓ **If you don't follow the directions, it could cause a personal injury, damage to the equipment or explosion**



- Do not assemble the products and wire with power applied to the system. Else it may cause an electric arc, which can result into unexpected and potentially dangerous action by field devices. Arching is explosion risk in hazardous locations. Be sure that the area is non-hazardous or remove system power appropriately before assembling or wiring the modules.
- Do not touch any terminal blocks or IO modules when system is running. Else it may cause the unit to an electric shock or malfunction.
- Keep away from the strange metallic materials not related to the unit and wiring works should be controlled by the electric expert engineer. Else it may cause the unit to a fire, electric shock or malfunction.

Caution!

✓ **If you disobey the instructions, there may be possibility of personal injury, damage to equipment or explosion. Please follow below Instructions.**

- Check the rated voltage and terminal array before wiring. Avoid the circumstances over 55°C of temperature. Avoid placing it directly in the sunlight.
- Avoid the place under circumstances over 85% of humidity.
- Do not place Modules near by the inflammable material. Else it may cause a fire.
- Do not permit any vibration approaching it directly.
- Go through module specification carefully, ensure inputs, output connections are made with the specifications. Use standard cables for wiring.
- Use Product under pollution degree 2 environment.

1.1.1. Symbols

<p>DANGER</p> 	<p>Identifies information about practices or circumstances that can cause an explosion in a hazardous environment, which may lead to personal injury or death property damage or economic loss.</p>
<p>IMPORTANT</p>	<p>Identifies information that is critical for successful application and understanding of the product.</p>
<p>ATTENTION</p> 	<p>Identifies information about practices or circumstances that can lead to personal injury, property damage, or economic loss.</p> <p>Attentions help you to identity a hazard, avoid a hazard, and recognize the consequences.</p>

1.1.2. Safety Notes

<p>DANGER</p> 	<p>The modules are equipped with electronic components that may be destroyed by electrostatic discharge. When handling the modules, ensure that the environment (persons, workplace and packing) is well grounded. Avoid touching conductive components, e.g. G-BUS Pin.</p>
--	--

1.1.3. Certification

c-UL-us UL Listed Industrial Control Equipment, certified for U.S. and Canada
See UL File E235505

FCC, Reach, RoHS- II, China RoHS

CE Certificate

EN 61000-6-2; Industrial Immunity
EN 61000-6-4; Industrial Emissions

2. Environment Specification

Environment Specification	
Operating Temperature	-40℃ ~ 60℃ : 1.5A full load is allowed
UL Temperature	-20℃~60℃
Storage Temperature	-40℃~85℃
Relative Humidity	5% ~ 90% non-condensing
Mounting	DIN rail
General Specification	
Shock Operating	IEC 60068-2-27
Vibration resistance	Based on IEC 60068-2-6 DNVGL-CD-0039 : Vibration Class B, 4g
Industrial Emissions	EN 61000-6-4/ALL : 2011
Industrial Immunity	EN 61000-6-2 : 2005
Installation Position	Vertical and horizontal installation is available.
Product Certifications	CE, UL, FCC

3. GN-9587 (PROFINET Network Adapter)

3.1. GN-9587 Specification

Items	Specification
Communication Specification	
Adapter Type	Slave node (Profinet)
Protocol	Profinet, Modbus RTU, DCP-Hello
Max. Expansion Module	32 Slots
Max. Data Size	Max. 1024 bytes
Max. Length Bus Line	Up to 100m from Ethernet Hub/Switch with twisted CAT5 UTP/STP
Max. Nodes	Limited by Profinet Specification
BaudRate	100Mbps, Auto-negotiation, Full duplex
Interface Connector	RJ-45 socket * 2pcs
IP-Address Setup	Via Master Device Software
Verial Port	RS232 for MODBUS/RTU, Touch Pannel
Serial Configuration (RS232)	Node : 1 (Fixed) Baud Rate : 115200 (Fixed) Data bit : 8 (Fixed) Parity bit : No parity (Fixed) Stop bit : 1 (Fixed)
Indicator	6 LED 1 Green/Red, Module Status (MOD) 1 Green, Physical Connection (NET) 1 Red, Network Error (Error) 1 Green/Red, Expansion I/O Module Status (IOS) 1 Green, System Power Status 1 Green, Field Power Status 2 LED (each RJ45 Connector) 1 Yellow, Link/Active 1 Green, Not used
Module Location	Starter module left side of G-Series System
Field Power Detection	About 14Vdc
General Specification	
UL System Power	Supply voltage : 24Vdc nominal, Class 2
System Power	Supply voltage : 24Vdc nominal Supply voltage range : 16~30Vdc Protection : Output current limit (Min. 1.5A) Reverse polarity protection
Power Dissipation	80mA typical @24Vdc
Current for I/O Module	1.5A @5Vdc
Isolation	System power to internal logic : Non-Isolation System power I/O driver : Isolation

UL Field Power	Supply voltage : 24Vdc nominal, Class 2
Field Power	Supply voltage : 24Vdc typical (Max.32Vdc) * Field Power range is defferent depending on IO module series. Refer to IO module's specification.
Max. Current Field Power Contact	DC 10A Max.
Wiring	I/O Cable Max. 2.0mm ² (AWG 14)
Torque	0.8Nm(7 lb-in)
Weight	177g
Module Size	54mm x 99mm x 70mm
Environment Condition	Refer to 'Environment Specification'

3.2. GN-9587 Wiring Diagram

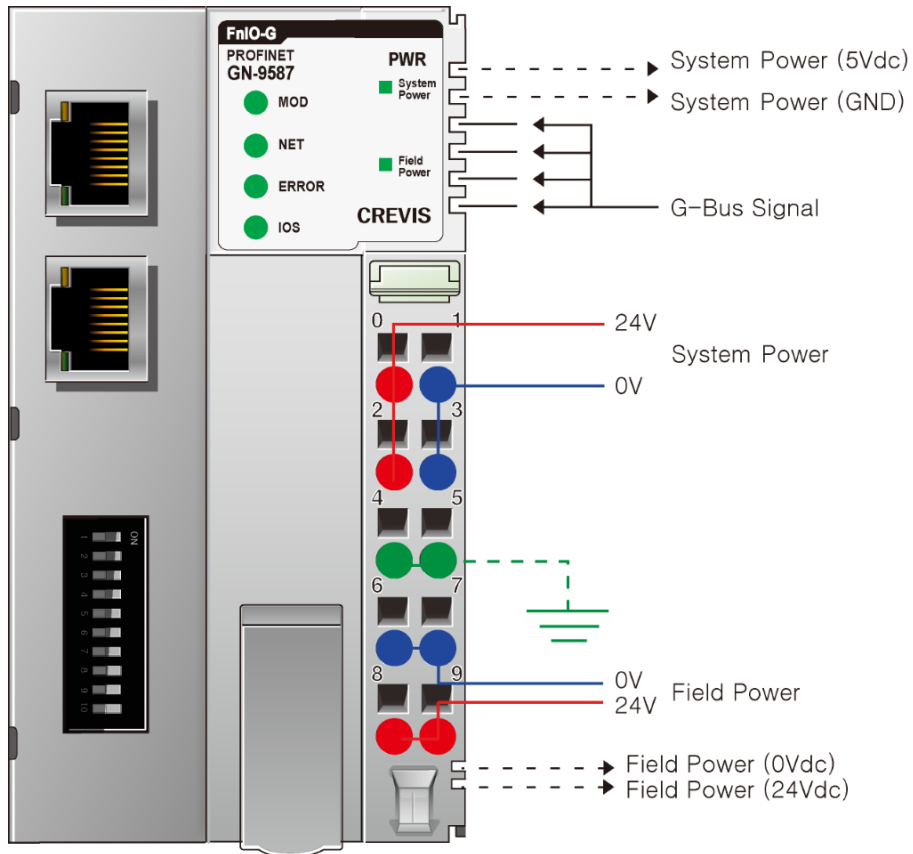

Pin No.	Signal Description	Signal Description	Pin No.
0	System Power, 24V	System Power, Ground	1
2	System Power, 24V	System Power, Ground	3
4	F.G	F.G	5
6	Field Power, Ground	Field Power, Ground	7
8	Field Power, 24V	Field Power, 24V	9

3.3. GN-9587 LED Indicator

3.3.1. LED Indicator

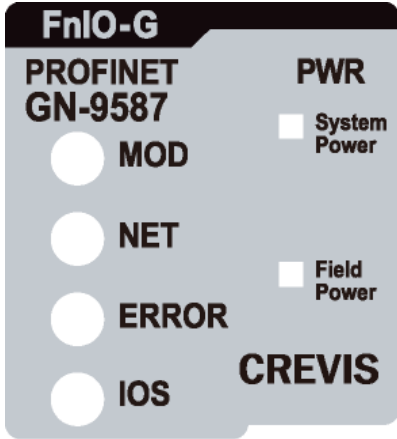

LED No.	LED Function / Description	LED Color
MOD	Module Status	Green/Red
NET	Network Status	Green/Red
ERROR	Error Status(Profinet)	Green
IOS	Extension Module Status	Green/Red
System Power	System Power Enable	Green
Field Power	Field Power Enable	Green

3.3.2. MOD(Module Status LED)

Status	LED	To indicate
Not Powered	OFF	power is not supplied to the unit.
Device Operational	Green	The unit is operating in normal condition.
Unrecoverable Fault	Red	unrecoverable fault. The device has an - Memory error or CPU watchdog error.

3.3.3. NET(Network Status LED)

State	LED	To indicate
Not Powered Not On-line	OFF	No power is supplied to the unit.
Communication	Green	Normal communication.
Communication Ready	Flashing Green	Link Connection.
Communication error	Red	Asic chip error

3.3.4. ERROR (Error Status LED)

Status	LED	To indicate :
No Error	OFF	No Error.
Connection error	Red	connection error. Communication Asic chip error.
Configuration error	Flashing Red	Can not data read of Profinet Chip or Invalid node switch number.

3.3.5. IOS LED (Expansion Module Status LED)

State	LED	To indicate
Not Powered	OFF	Device may not be powered.
No Expansion Module	Flashing Red	Adapter has no expansion module
Internal Bus Connection, When Exchanging I/O	Green	Exchanging I/O data.
Expansion Configuration Failed	Red	One or more expansion module occurred in fault state. - Detected invalid expansion module ID. - Overflowed Input/Output Size - Too many expansion module - Initialization failure - Communication failure. - Changed expansion module configuration. - Mismatch vendor code between adapter and expansion module.

3.3.6. Field Power, System Power LED (Field Power, System Power Status LED)

State	LED	To indicate
Not supplied field, system power	OFF	Not supplied 24Vdc field power.
Supplied field, system power	Green	Supplied 24Vdc field power.

3.4. GN-9587 Electrical Interface

3.4.1. PROFINET Connector

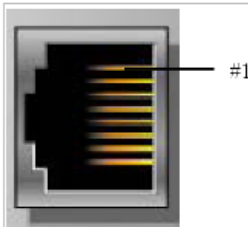

Shielded RJ-45 Socket

RJ-45	Singal Name	Description
1	TD+	Transmit +
2	TD-	Transmit -
3	RD+	Receive +
4	-	
5	-	
6	TD-	Receive -
7	-	
8	-	
Case	Shield	

3.4.2. Dip Switch



DIP Pole#	Description	
1	Node ID Bit 0	Device Name (GN9587-XX) -XX must a value between 1~99 * If the switch value is 0, it switches to the "User Setting Station Name" function
2	Node ID Bit 1	
3	Node ID Bit 2	
4	Node ID Bit 3	
5	Node ID Bit 4	
6	Node ID Bit 5	
7	Node ID Bit 6	
8	Speed-Up for DCP-Hello Protocol (On: used, Off : not used)	
9	Setting for DATA FORMAT (On: MOTORORA, Off : INTEL)	
10	PLC STOP Action (On: Last Hold Value, Off : I/O All Clear)	

- **When the dip switch is not set to non-zero (1~99):**

If the decimal value of the dip switch is not zero (0), the name of device will be fixed as "GN9587-xx" (xx: 1~99). You must put the fixed device name.

- **When the dip switch is set to zero(0):**

GN-9587 Devices on a PROFINET subnet must have unique names. The device names must satisfy DNS naming conventions. This means that the following rules must be observed:

- Names are limited to a total of 127 characters (letters, numbers, dashes or dots)
 - Any component part (that is, a character string between two dots) of the device name may only be up to 63 characters long.
 - Names cannot contain any special characters such as umlauts, parentheses, underscores, forward or backward slashes, empty spaces, etc. The dash is the only special character allowed.
 - Names must not begin or end with the "-" or "." characters.
 - Names must not have the format n.n.n.n (where n = 0...999).
 - The device name must not start with numbers.
 - If you want to change the IP address in non-volatile memory, please refer to Chapter3. (Editing Ethernet Nodes)
- Device names are assigned to PROFINET IO device when the device is being set up and placed in operation for the first time ("commissioned").

The default name is "GN9587-address".

3.4.3. RS232 Port for MODBUS/RTU, Touch Panel or IOGuide

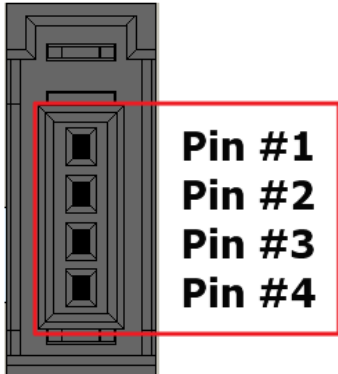

Pin#	Signal Name	Description
1	Reserved	----
2	TXD	RS232 TXD
3	RXD	RS232 RXD
4	GND	RS232 GND

4. I/O Process Image Map

An expansion module may have 3 types of data as I/O data, configuration parameter and memory register. The data exchange between network adapter and expansion modules is done via an I/O process image data by G-Series Internal Bus protocol. The following figure shows the data flow of process image between network adapter and expansion modules.

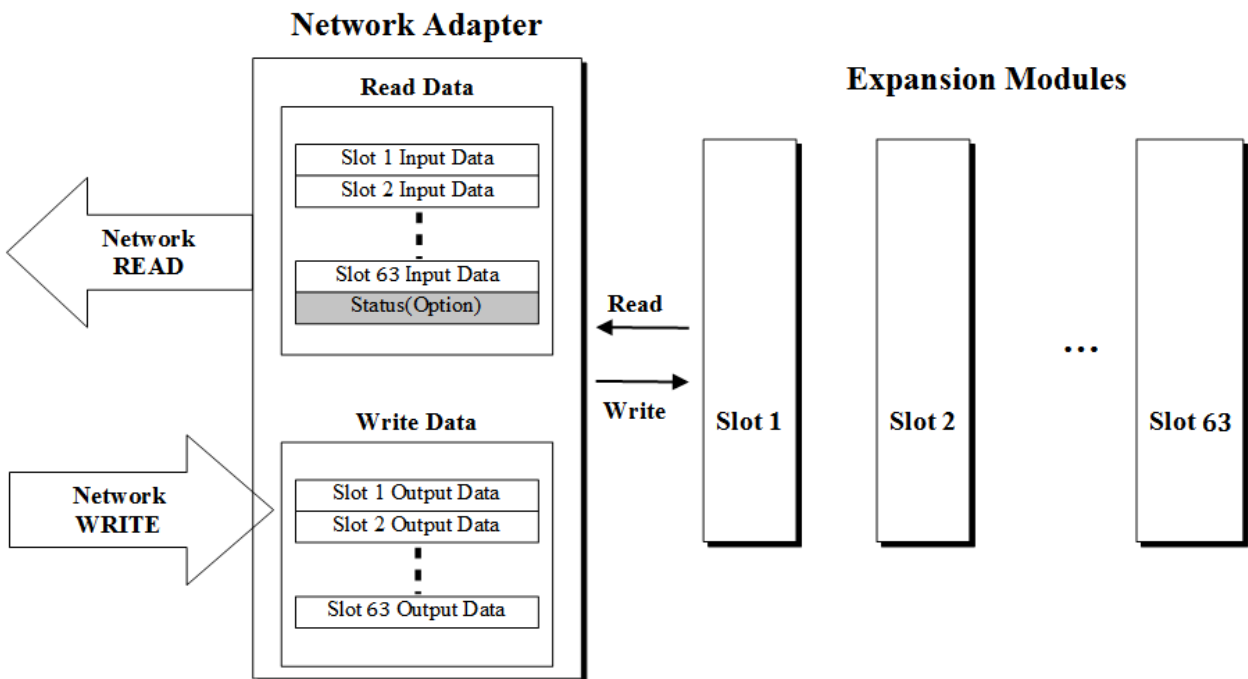

4.1. Mapping Data into Image Table

4.1.1. Discrete Input Module

- . 4 Point Input Module

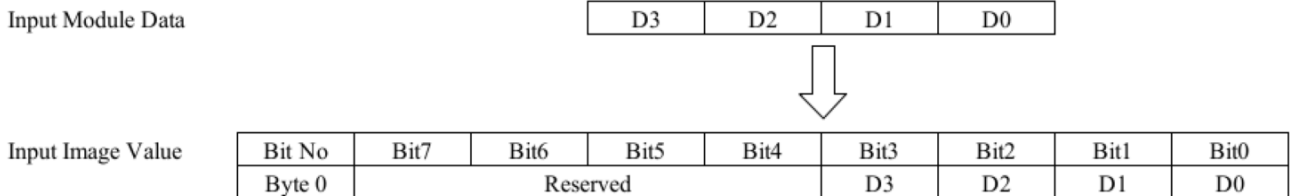

- . 8 Point Input Module

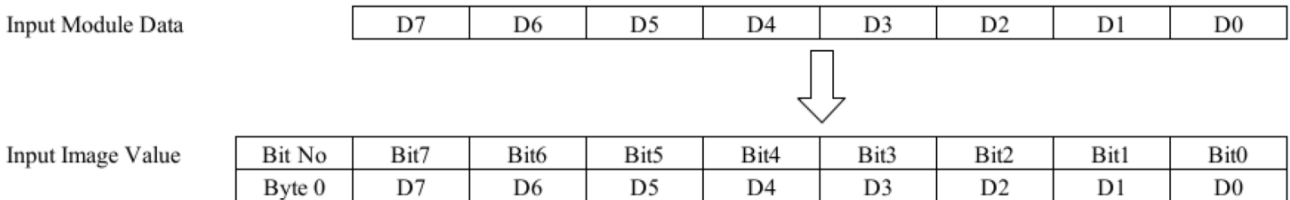

- . 16 Point Input Module

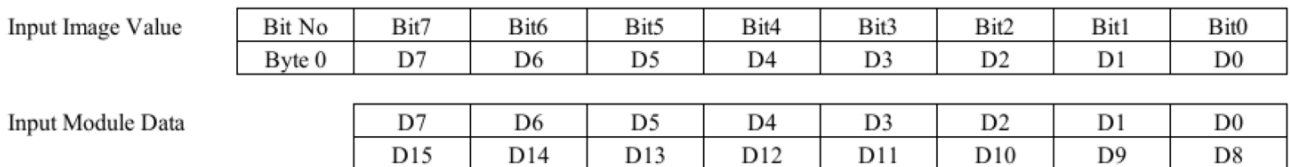

- . 32 Point Input Module

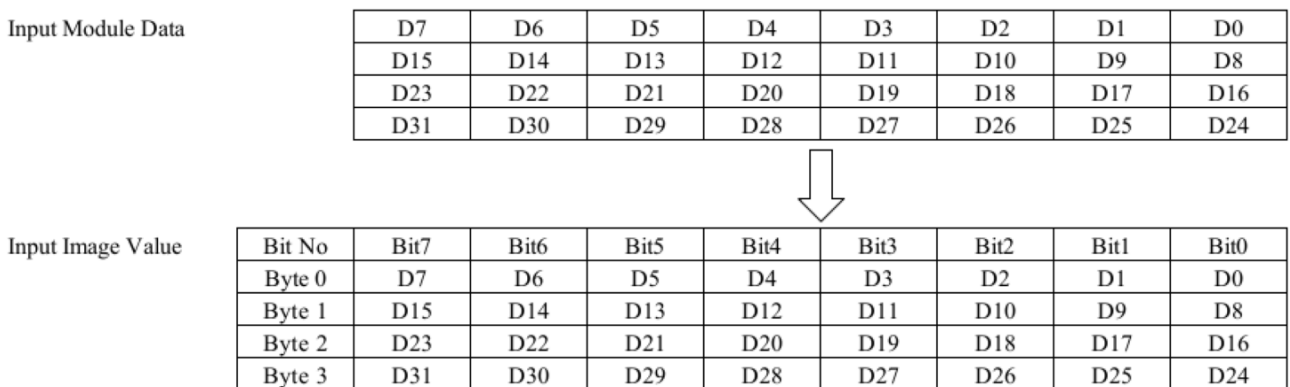

4.1.2. Discrete Output Module

- . 4 Point Input Module

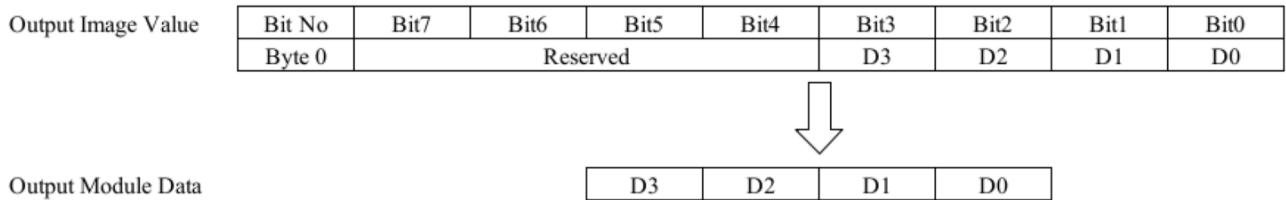

- . 8 Point Input Module

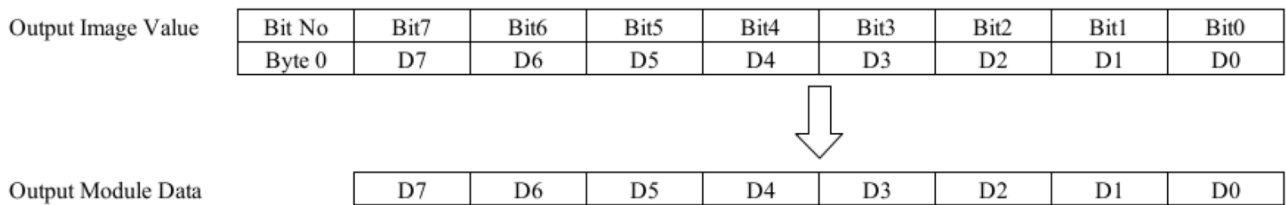

- . 16 Point Input Module

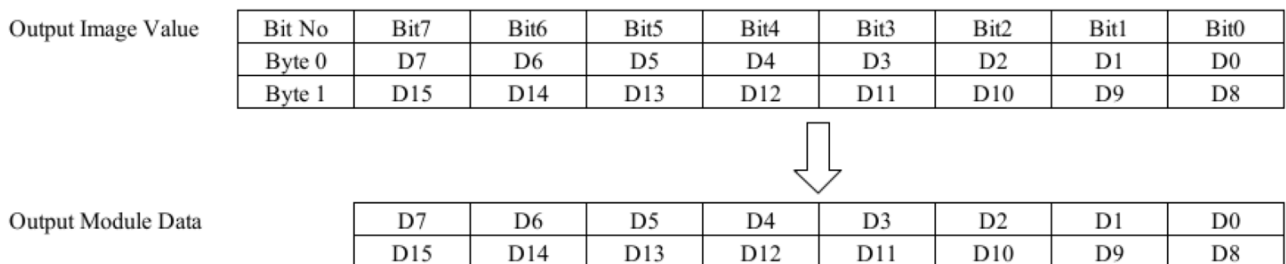

- . 32 Point Input Module

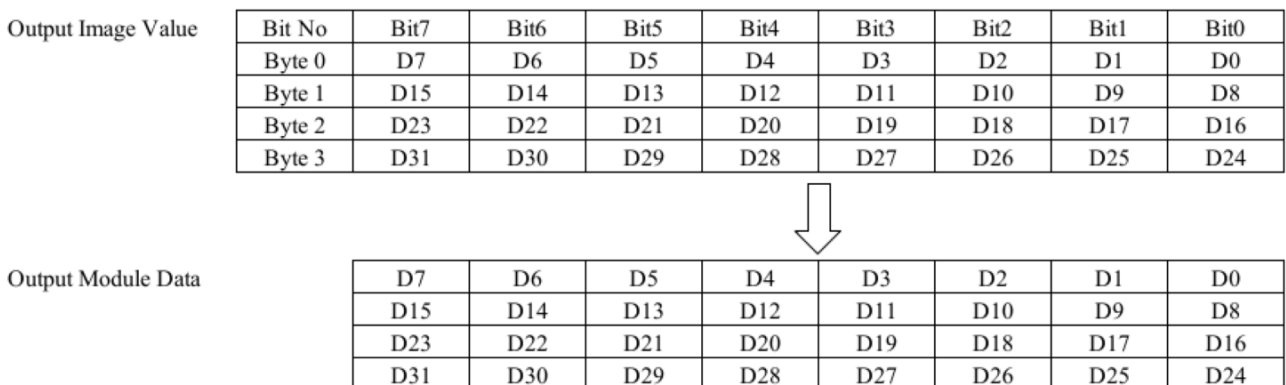

4.1.3. Analog Input Module

- . 4 Channel Analog Input Module

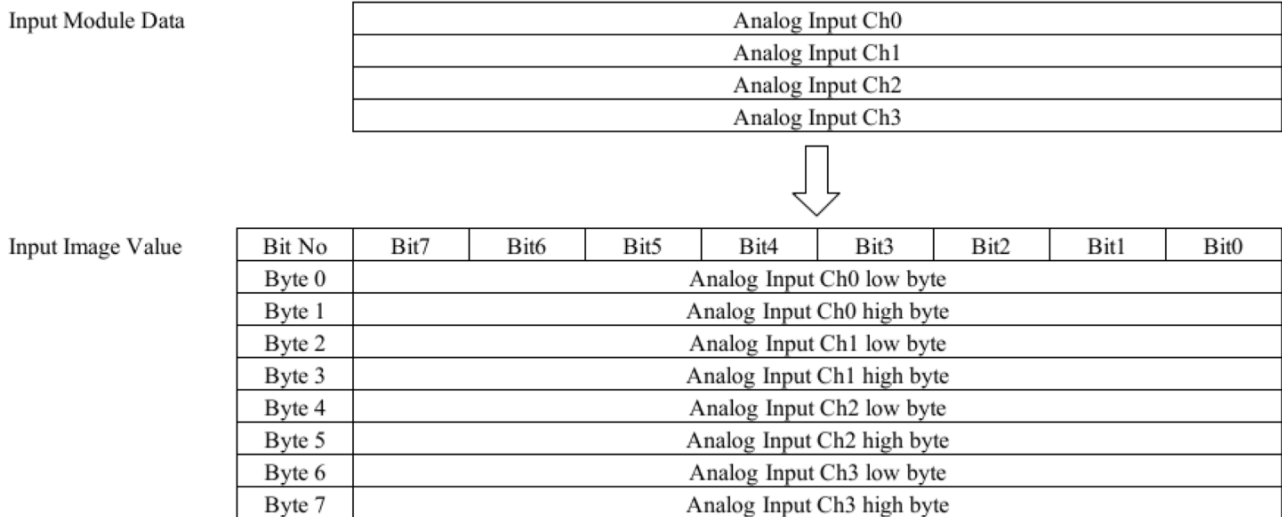

- . 8 Channel Analog Input Module

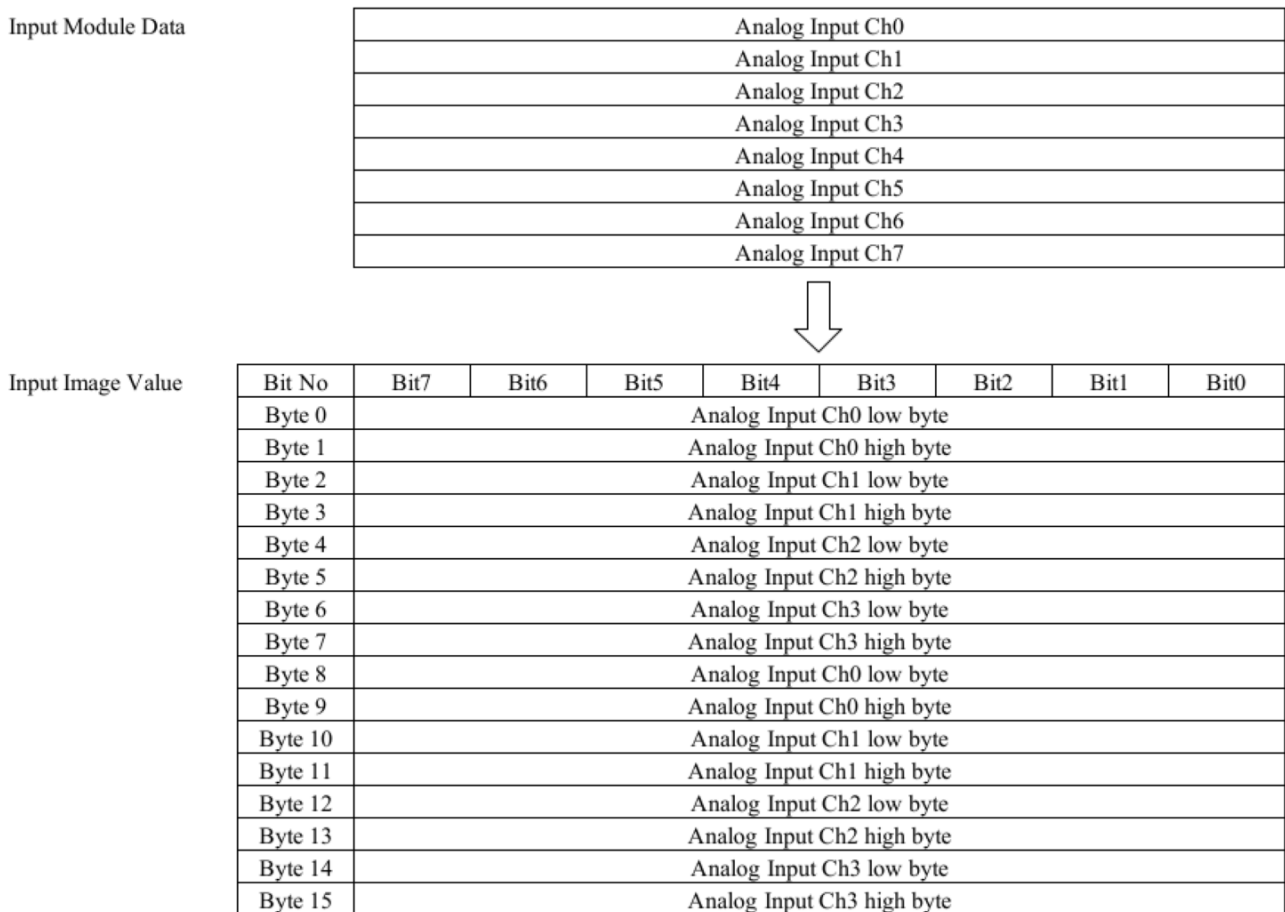

4.1.4. Analog Output Module

- . 4 Channel Analog Input Module

Output Image Value	Bit No	Bit7	Bit6	Bit5	Bit4	Bit3	Bit2	Bit1	Bit0
Byte 0	Analog Output Ch0 low byte								
Byte 1	Analog Output Ch0 high byte								
Byte 2	Analog Output Ch1 low byte								
Byte 3	Analog Output Ch1 high byte								
Byte 4	Analog Output Ch2 low byte								
Byte 5	Analog Output Ch2 high byte								
Byte 6	Analog Output Ch3 low byte								
Byte 7	Analog Output Ch3 high byte								



Output Module Data	Analog Output Ch0
	Analog Output Ch1
	Analog Output Ch2
	Analog Output Ch3

- . 8 Channel Analog Input Module

Output Image Value	Bit No	Bit7	Bit6	Bit5	Bit4	Bit3	Bit2	Bit1	Bit0
Byte 0	Analog Output Ch0 low byte								
Byte 1	Analog Output Ch0 high byte								
Byte 2	Analog Output Ch1 low byte								
Byte 3	Analog Output Ch1 high byte								
Byte 4	Analog Output Ch2 low byte								
Byte 5	Analog Output Ch2 high byte								
Byte 6	Analog Output Ch3 low byte								
Byte 7	Analog Output Ch3 high byte								
Byte 8	Analog Output Ch4 low byte								
Byte 9	Analog Output Ch4 high byte								
Byte 10	Analog Output Ch5 low byte								
Byte 11	Analog Output Ch5 high byte								
Byte 12	Analog Output Ch6 low byte								
Byte 13	Analog Output Ch6 high byte								
Byte 14	Analog Output Ch7 low byte								
Byte 15	Analog Output Ch7 high byte								



Output Module Data	Analog Output Ch0
	Analog Output Ch1
	Analog Output Ch2
	Analog Output Ch3
	Analog Output Ch4
	Analog Output Ch5
	Analog Output Ch6
	Analog Output Ch7

4.2. Example of Input Process Image (Input Register) Map

Input image data depends on slot position and expansion slot data type. Input process image data is only ordered by expansion slot position.

- For example slot configuration

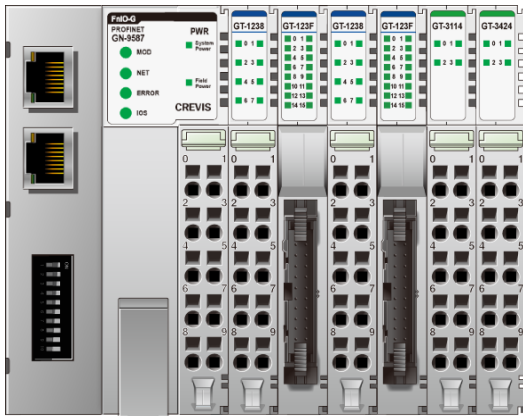

Soft Address	Module Description
#0	PROFINET Adapter
#1	8-discrete input
#2	16-discrete input
#3	8-discrete input
#4	16-discrete input
#5	8-analog input
#6	8-analog input

- Input Process Image

Byte	Slot#	Bit 7	Bit 6	Bit 5	Bit 4	Bit 3	Bit 2	Bit 1	Bit 0
Read byte 0	Slot 1	Discrete Input 8 Point							
Read byte 1	Slot 2	Discrete Input 16 Point low byte							
Read byte 2		Discrete Input 16 Point high byte							
Read byte 3	Slot 3	Discrete Input 8 Point							
Read byte 4	Slot 4	Discrete Input 16 Point low byte							
Read byte 5		Discrete Input 16 Point high byte							
Read byte 6	Slot 5	Analog Input Ch0 low byte							
Read byte 7		Analog Input Ch0 high byte							
Read byte 8		Analog Input Ch1 low byte							
Read byte 9		Analog Input Ch1 high byte							
Read byte 10		Analog Input Ch2 low byte							
Read byte 11		Analog Input Ch2 high byte							
Read byte 12		Analog Input Ch3 low byte							
Read byte 13		Analog Input Ch3 high byte							
Read byte 14	Slot 6	Analog Input Ch0 low byte							
Read byte 15		Analog Input Ch0 high byte							
Read byte 16		Analog Input Ch1 low byte							
Read byte 17		Analog Input Ch1 high byte							
Read byte 18		Analog Input Ch2 low byte							
Read byte 19		Analog Input Ch2 high byte							
Read byte 20		Analog Input Ch3 low byte							
Read byte 21		Analog Input Ch3 high byte							

4.3. Example of Output Process Image (Output Register) Map

Output image data depends on slot position and expansion slot data type. Output process image data is only ordered by expansion slot position.

- For example slot configuration

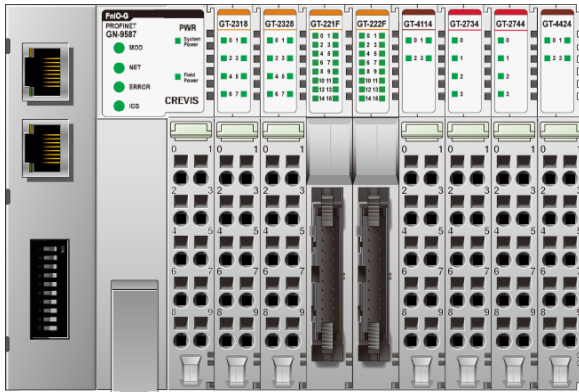

Slot Address	Module Description
#0	PROFINET Adapter
#1	8-discrete output
#2	8-discrete output
#3	16-discrete output
#4	16-discrete output
#5	4-analog output
#6	4-relay output
#7	4-relay output
#8	4-analog output

Output Process Image Mode#0 (Uncompressed Input Processing Data), default output image

Byte	Bit 7	Bit 6	Bit 5	Bit 4	Bit 3	Bit 2	Bit 1	Bit 0
0	Discrete Output 8 pts (Slot#1)							
1	Discrete Output 8 pts (Slot#2)							
2	Analog Output Ch0 low byte (Slot#3)							
3	Analog Output Ch0 high byte (Slot#3)							
4	Analog Output Ch1 low byte (Slot#3)							
5	Analog Output Ch1 high byte (Slot#3)							
6	Analog Output Ch2 low byte (Slot#3)							
7	Analog Output Ch2 high byte (Slot#3)							
8	Analog Output Ch3 low byte (Slot#3)							
9	Analog Output Ch3 high byte (Slot#3)							
10	Discrete Output low 4 pts (Slot#4)							
12	Discrete Output low 4 pts (Slot#5)							
13	Discrete Output low 8 pts (Slot#6)							
14	Discrete Output low 8 pts (Slot#7)							
15	Analog Output Ch0 low byte (Slot#8)							
16	Analog Output Ch0 high byte (Slot#8)							
17	Analog Output Ch1 low byte (Slot#8)							
18	Analog Output Ch1 high byte (Slot#8)							
19	Analog Output Ch2 low byte (Slot#8)							
20	Analog Output Ch2 high byte (Slot#8)							
21	Analog Output Ch3 low byte (Slot#8)							
22	Analog Output Ch3 high byte (Slot#8)							
24	Discrete output low 8 pts (Slot#9)							
25	Discrete output low 8 pts (Slot#10)							
26	Discrete output low 8 pts (Slot#10)							

4.4. MODBUS Special Register Map

The special register map can be accessed by function code 3, 4, 6 and 16. Also the special register map must be accessed by read/write of every each address (one address).

4.4.1. Adapter Identification Special Register (0x1000,4096)

Address	Access	Type, Size	Description
0x1000(4096)	Read	1 word	Vendor ID = 0x0140(320), Crevis. Co., Ltd.
0x1001(4097)	Read	1 word	Device type = 0x000C, Network Adapter
0x1002(4098)	Read	1 word	Product Code = 0x9080
0x1003(4099)	Read	1 word	Firmware revision, if 0x0101, revision 1.01
0x1004(4100)	Read	2 words	Product unique serial number
0x1005(4101)	Read	String upto 34bytes	Product name string (ASCII) "GN-9587,PROFINET(MRP,FSU), GBUS"
0x1006(4102)	Read	1 word	Sum check of EEPROM
0x1010(4112)	Read	2 words	Firmware release date
0x1011(4113)	Read	2 words	Product manufacturing inspection date
0x101E(4126)	Read	7 Words -. 1 word -. 1 word -. 1 word -. 1 word -. 1 word -. 2 words	Composite Id of following address * RTU mode 0x1100(4352), Modbus RS232 Node. (Fixed 0x0001) 0x1000(4096), Vendor ID 0x1001(4097), Device type 0x1002(4098), Product code 0x1003(4099), Firmware revision 0x1004(4100), Product serial number

4.4.2. Other Time Special Register (0x1028,4136)

Address	Access	Type, Size	Description
0x1028(4136)	Read	1 word	IO update time, main loop time. (1usec unit)

4.4.3. Adapter IP/MAC Address Special Register (0x1050,4176)

Address	Access	Type, Size	Description
0x1050(4176)	Read/Write	2 words	IP address. If 192.168.123.1, then 0x017B, 0xA8C0. After update this value, IP address, Subnet mask and Gateway are applied as new one.
0x1051(4177)	Read/Write	2 words	Subnet mask. If 255.255.255.0, then 0x00FF, 0xFFFF.
0x1052(4178)	Read/Write	2 words	Gateway. If 192.168.123.254, then 0xFE7B, 0xA8C0.
0x1053(4179)	Read	3 words	Ethernet physical address (MAC-ID). If 11-22-33-44-55-66, then 0x2211, 0x4433, 0x6655.

4.4.4. Adapter Information Special Register (0x1100,4352)

Address	Access	Type, Size	Description																			
0x1100(4352)*	Read	1 word	Current STATION-NUMBER.(DIP SW Number)																			
0x1102(4354)	Read	1 word	Start address of input image word register. =0x0000																			
0x1103(4355)	Read	1 word	Start address of output image word register. =0x0800																			
0x1104(4356)	Read	1 word	Size of input image word register.																			
0x1105(4357)	Read	1 word	Size of output image word register.																			
0x1106(4358)	Read	1 word	Start address of input image bit. = 0x0000																			
0x1107(4359)	Read	1 word	Start address of output image bit. =0x1000																			
0x1108(4360)	Read	1 word	Size of input image bit.																			
0x1109(4361)	Read	1 word	Size of output image bit.																			
0x110A(4362)	Read	1 word	Update time for cyclic data change (same as 0x1028)																			
0x110D(4365)	Read	1 word	Current Dip Switch State and Field Power Status (MSB) ex) Flash memory Value using, Dip SW(0x01), Field Power On = 0x8201																			
0x110E(4366)	Read	upto 33words	Expansion slot's GT-number including GN First 1word is adapter's number, if GN-9587, then 0x9587																			
0x1110(4368)	Read	1 word	Number of expansion slot																			
0x1113(4371)	Read	upto 33words	Expansion slot Module Id. First 1word is adapter's module id.																			
0x1119(4377)	Read	1 word	Low byte is internal bus status. Zero value means 'no error'.																			
			<table border="1"> <thead> <tr> <th>Reserve</th> <th>Internal bus status(G-Bus)</th> </tr> </thead> <tbody> <tr> <td></td> <td>0x00 : OPERATING</td> </tr> <tr> <td></td> <td>0x02 : CONNECT_FAULT</td> </tr> <tr> <td></td> <td>0x03 : CONFIG_FAULT</td> </tr> <tr> <td></td> <td>0x04 : NO_EXPANSION</td> </tr> <tr> <td></td> <td>0x05 : NVALID_ATTR_VALUE</td> </tr> <tr> <td></td> <td>0x06 : TOO_MUCH_DATA</td> </tr> <tr> <td></td> <td>0x07 : VENDOR_ERROR</td> </tr> <tr> <td></td> <td>0x08 : NOT_EXPECTED_SLOT</td> </tr> <tr> <td></td> <td>0x09 : CRC_ERROR</td> </tr> <tr> <td></td> <td>0x80 : NO FIELD POWER</td> </tr> </tbody> </table>	Reserve	Internal bus status(G-Bus)		0x00 : OPERATING		0x02 : CONNECT_FAULT		0x03 : CONFIG_FAULT		0x04 : NO_EXPANSION		0x05 : NVALID_ATTR_VALUE		0x06 : TOO_MUCH_DATA		0x07 : VENDOR_ERROR		0x08 : NOT_EXPECTED_SLOT	
Reserve	Internal bus status(G-Bus)																					
	0x00 : OPERATING																					
	0x02 : CONNECT_FAULT																					
	0x03 : CONFIG_FAULT																					
	0x04 : NO_EXPANSION																					
	0x05 : NVALID_ATTR_VALUE																					
	0x06 : TOO_MUCH_DATA																					
	0x07 : VENDOR_ERROR																					
	0x08 : NOT_EXPECTED_SLOT																					
	0x09 : CRC_ERROR																					
	0x80 : NO FIELD POWER																					
0x111D(4381)	Read	1 word	Adapter G-Series Revision.																			

* After the system is reset, the new "Set Value" action is applied.

** If the slot location is changed, set default value automatically (all expansion slot are live).

4.4.5. Expansion Slot Information Special Register (0x2000,8192)

Each expansion slot has 0x20(32) address offset and same information structure.

Slot#1 0x2000(8192)~0x201F(8223) Slot#2 0x2020(8224)~0x203F(8255)
 Slot#3 0x2040(8256)~0x205F(8287) Slot#4 0x2060(8288)~0x207F(8319)
 Slot#5 0x2080(8320)~0x209F(8351) Slot#6 0x20A0(8352)~0x20BF(8383)
 Slot#7 0x20C0(8384)~0x20DF(8415) Slot#8 0x20E0(8416)~0x20FF(8447)
 Slot#9 0x2100(8448)~0x211F(8479) Slot#10 0x2120(8480)~0x213F(8511)
 Slot#11 0x2140(8512)~0x215F(8543) Slot#12 0x2160(8544)~0x217F(8575)
 Slot#13 0x2180(8576)~0x219F(8607) Slot#14 0x21A0(8608)~0x21BF(8639)

 Slot#32 0x23E0(9184)~0x23FF(9215)

Address Offset	Expansion Slot#1	Expansion Slot#2	Expansion Slot#3	Expansion Slot#4	Expansion Slot#63
+ 0x00(+0)	0x2000(8192)	0x2020(8224)	0x2040(8256)	0x2060(8288)	0x27C0(10176)
+ 0x01(+1)	0x2001(8193)	0x2021(8225)	0x2041(8257)	0x2061(8289)		0x27C1(10177)
+ 0x02(+2)	0x2002(8194)	0x2022(8226)	0x2042(8258)	0x2062(8290)		0x27C2(10178)
+ 0x03(+3)	0x2003(8195)	0x2023(8227)	0x2043(8259)	0x2063(8291)		0x27C3(10179)
+ 0x04(+4)	0x2004(8196)	0x2024(8228)	0x2044(8260)	0x2064(8292)		0x27C4(10180)
+ 0x05(+5)	0x2005(8197)	0x2025(8229)	0x2045(8261)	0x2065(8293)		0x27C5(10181)
+ 0x06(+6)	0x2006(8198)	0x2026(8230)	0x2046(8262)	0x2066(8294)		0x27C6(10182)
+ 0x07(+7)	0x2007(8199)	0x2027(8231)	0x2047(8263)	0x2067(8295)		0x27C7(10183)
+ 0x08(+8)	0x2008(8200)	0x2028(8232)	0x2048(8264)	0x2068(8296)		0x27C8(10184)
+ 0x09(+9)	0x2009(8201)	0x2029(8233)	0x2049(8265)	0x2069(8297)		0x27C9(10185)
+ 0x0A(+10)	0x200A(8202)	0x202A(8234)	0x204A(8266)	0x206A(8298)		0x27CA(10186)
+ 0x0B(+11)	0x200B(8203)	0x202B(8235)	0x204B(8267)	0x206B(8299)		0x27CB(10187)
+ 0x0C(+12)	0x200C(8204)	0x202C(8236)	0x204C(8268)	0x206C(8300)		0x27CC(10188)
+ 0x0D(+13)	0x200D(8205)	0x202D(8237)	0x204D(8269)	0x206D(8301)		0x27CD(10189)
+ 0x0E(+14)	0x200E(8206)	0x202E(8238)	0x204E(8270)	0x206E(8302)		0x27CE(10190)
+ 0x0F(+15)	0x200F(8207)	0x202F(8239)	0x204F(8271)	0x206F(8303)		0x27CF(10191)
+ 0x10(+16)	0x2010(8208)	0x2030(8240)	0x2050(8272)	0x2070(8304)		0x27D0(10192)
+ 0x11(+17)	0x2011(8209)	0x2031(8241)	0x2051(8273)	0x2071(8305)		0x27D1(10193)
+ 0x12(+18)	0x2012(8210)	0x2032(8242)	0x2052(8274)	0x2072(8306)		0x27D2(10194)
+ 0x13(+19)	0x2013(8211)	0x2033(8243)	0x2053(8275)	0x2073(8307)		0x27D3(10195)
+ 0x14(+20)	0x2014(8212)	0x2034(8244)	0x2054(8276)	0x2074(8308)		0x27D4(10196)
+ 0x15(+21)	0x2015(8213)	0x2035(8245)	0x2055(8277)	0x2075(8309)		0x27D5(10197)
+ 0x16(+22)	0x2016(8214)	0x2036(8246)	0x2056(8278)	0x2076(8310)		0x27D6(10198)
+ 0x17(+23)	0x2017(8215)	0x2037(8247)	0x2057(8279)	0x2077(8311)		0x27D7(10199)
+ 0x18(+24)	0x2018(8216)	0x2038(8248)	0x2058(8280)	0x2078(8312)		0x27D8(10200)
+ 0x19(+25)	0x2019(8217)	0x2039(8249)	0x2059(8281)	0x2079(8313)		0x27D9(10201)
+ 0x1A(+26)	0x201A(8218)	0x203A(8250)	0x205A(8282)	0x207A(8314)		0x27DA(10202)
+ 0x1B(+27)	0x201B(8219)	0x203B(8251)	0x205B(8283)	0x207B(8315)		0x27DB(10203)
+ 0x1C(+28)	0x201C(8220)	0x203C(8252)	0x205C(8284)	0x207C(8316)		0x27D8C(10204)
+ 0x1D(+29)	0x201D(8221)	0x203D(8253)	0x205D(8285)	0x207D(8317)		0x27DD(10205)
+ 0x1E(+30)	0x201E(8222)	0x203E(8254)	0x205E(8286)	0x207E(8318)		0x27DE(10206)
+ 0x1F(+31)	0x201F(8223)	0x203F(8255)	0x205F(8287)	0x207F(8319)		0x27DF(10207)

Address Offset	Access	Type, Size	Description
+ 0x02(+2) **	Read	1word	Input start register address of input image word this slot.
+ 0x03(+3) **	Read	1word	Input word's bit offset of input image word this slot.
+ 0x04(+4) **	Read	1word	Output start register address of output image word this slot.
+ 0x05(+5) **	Read	1word	Output word's bit offset of output image word this slot.
+ 0x06(+6) **	Read	1word	Input bit start address of input image bit this slot.
+ 0x07(+7) **	Read	1word	Output bit start address of output image bit this slot.
+ 0x08(+8) **	Read	1word	Size of input bit this slot
+ 0x09(+9) **	Read	1word	Size of output bit this slot
+ 0x0A(+10) **	Read	n word	Read input data this slot
+ 0x0B(+11) **	Read/Write	n word	Read/write output data this slot
+ 0x0E(+14)	Read	1word	RT-number, if RT-1238, returns 0x1238
+ 0x0F(+15)	Read	String up to 74byte	First 1word is length of valid character string. If RT-1238, returns "00 1E 52 54 2D 31 32 33 38 2C 20 38 44 49 2C 20 32 34 56 64 63 2C 20 55 6E 69 76 65 72 73 61 6C 00 00" Valid character size = 0x001E =30 characters, "RT-1238, 8DI, 24Vdc, Universal"
+ 0x10(+16)	Read	1word	Size of configuration parameter byte
+ 0x11(+17) **	Read/Write	n word	Read/write Configuration parameter data, up to 8byte. Refer to A.2 ***
+ 0x17(+23) **	Read/Write	2word	Firmware Revision
+ 0x19(+25) **	Read/Write	2word	Firmware release date.

5. MODBUS Reference

MODBUS Reference Documents

<http://www.modbus.org>

MODBUS Tools

<http://www.modbustools.com>, modbus poll

<http://www.win-tech.com>, modscan32

6. Dimension

6.1. GN-9587

(mm)

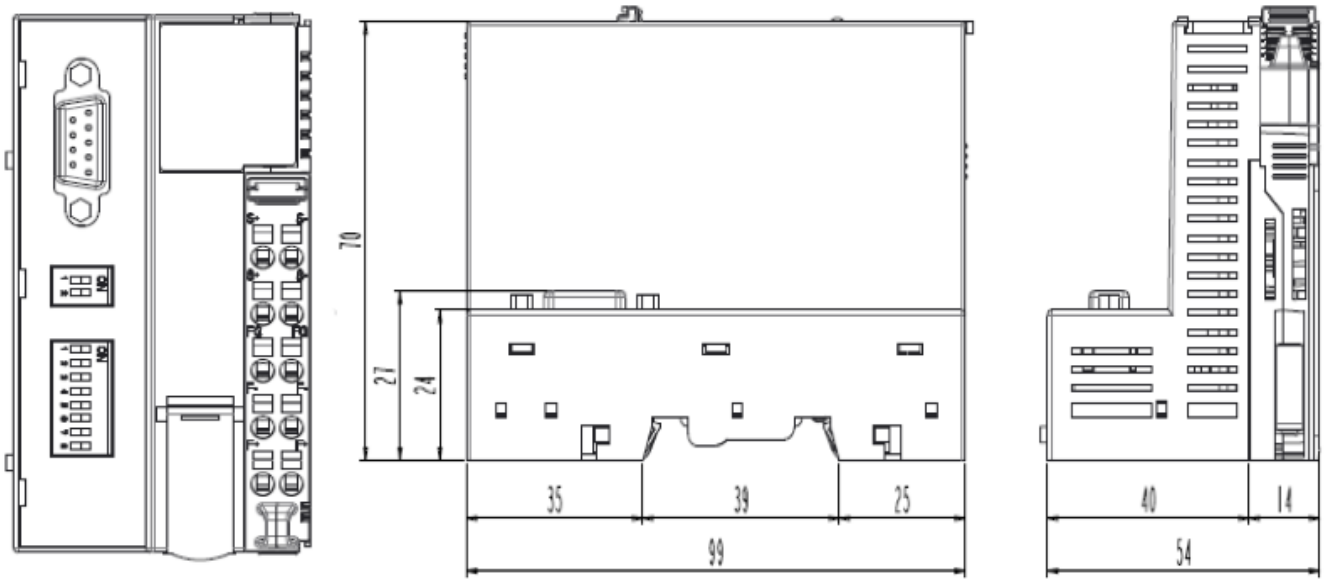

7. Mechanical Set Up

7.1. Total Expansion

The number of the module assembly that can be connected is 63. So the maximum length is 426mm
Exception.

7.2. Plugging and Removal of the Components.

DANGER



Before work is done on the components, the voltage supply must be turned off.

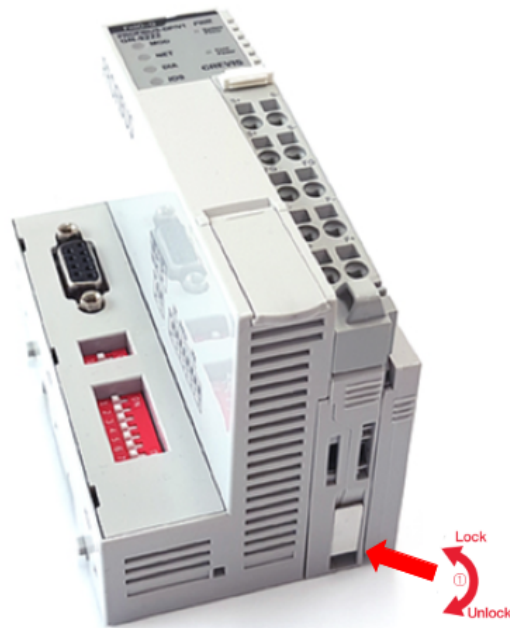

As above figure in order to safeguard the FnIO module from jamming, it should be fixed onto the DIN rail with locking level. To do so, fold on the upper of the locking lever.

To pull out the FnIO module, unfold the locking lever as below figure.



7.3. Internal G-Bus/Field Power Contacts

Communication between the NA series and the expansion module as well as system / field power supply of the bus modules is carried out via the internal bus. It is comprised of 6 data pin and 2 field power pin.

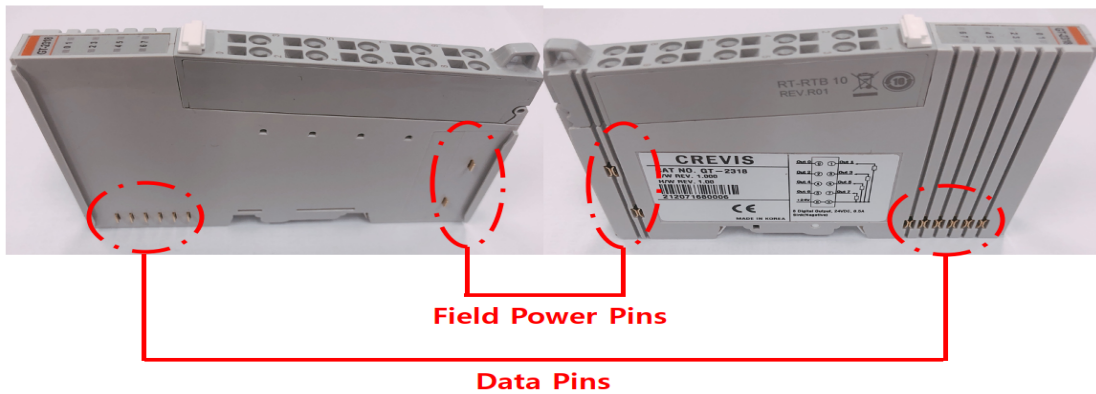

Do not touch data and field power pins in order to avoid soiling and damage by ESD noise.

8. Parameter

8.1. GN-9587

- . Can not be used.

8.2. GN-9587 PROFINET IO Characteristics

8.2.1. Device Identity

Item	Value
Vendor	CREVIS
Vendor ID	0X0140
Product family	CREVIS FnIO System
Device ID	0X9587
Details	GN9587 PROFINET IO Device

8.2.2. Device Access Point

Item	Value
Module Ident Number	0x80010000
Details	GN9587 PROFINET IO Device
Vendor Name	CREVIS
Order Number	GN-9587
Category	CREVIS PROFINET I/O
Software Version	V1.0
Hardware Version	V1.0
Maximal Input Length	1440 Bytes
Maximal Output Length	1440 Bytes
Physical Slots	0..32
Minimal Device Interval	0.25msec
Based on	NP40
DNS Compliant Name	GN9587-address
Supports Extended Assignment of IP Address	No
Fixed in Slots	0
Instance Field of the Object UUID	1
Supports Multiple Write	Yes
Requires IOPS/IOCS	Yes
Requires Engineering tool which supports at least GSDML Version	V2.25

8.2.3. Sub-slot of GN-9587

Item	Value
Sub-slot Number	Sub-slot Label
32768(0x8000)	X1
32769(0x8001)	P1
32770(0x8002)	P2

Sub-module	
Sub-module Ident Number	0x00000001
Sub-module Ident Number	0x00000002
Sub-slot Number	32768 (0x8000)
Supports Real time Class	RT_CLASS_1, RT_CLASS_3
Supports Isochronous Mode	No
Supported Protocols	SNMP; LLDP
DCP_Hello Supported	Yes
PTP Boundary Supported	Yes
DCP Boundary Supported	Yes
Supported Send-clock Factors (Base 31.25us)	8 16 32 64 128
Supported Reduction Ratios	1 2 4 8 16 32 64 128 256 512

Port 1 : Port 1	
Sub-module Ident Number	0x00000003
Sub-slot Number	32769 (0x8001)
MAU Type	100BASETXFD
Port 2 : Port 2	
Sub-module Ident Number	0x00000003
Sub-slot Number	32770 (0x8002)
MAU Type	100BASETXFD

9. Trouble Shooting

9.1. How to diagnose by LED indicator

LED Status	Cause	Action
All LED turns off	- No power	- Check main power Cable
MOD LED is red	- Occurrence critical error in firmware	- Contact Sales team and send module for repair.
NET LED turns off	Failure of communication with Master	Check main power for master and communication cable.
NET LED flashed green	Failure of exchanging data with master	Check status in software for Master configuration.
NET LED is red	Failed communication	- Contact Sales team and send module for repair.
DIA Flashing Red with MOD led is red	Device has hardware checking error.	- Contact Sales team and send module for repair.
DIA Flashing Red with IOS led is red	Device has expansion module error.	- Contact Sales team and send module for repair.
DIA Flashing Red	Failed to initialize expansion module - Overflow Input/Output size. (244bytes / 244bytes) - Overflow Configuration data size. (244bytes / 244bytes) - Too many expansion module. (Max 63 slot) - Mismatch vendor code between adapter and expansion module.	- Use expansion slot up to 63. - Compose that IO total size is not excess. - Check status of expansion IO connection. - Check the vendor code of module.
IOS LED turns off	- Device may not be powered.	- Check main power Cable
IOS LED flashes red	- Adapter has no expansion module	- Add one or more expansion modules.
IOS LED is red	One or more expansion module occurred in fault state. - Detected invalid expansion module ID. - Overflowed Input/Output Size - Too many expansion module - Initialization failure - Communication failure. - Changed expansion module configuration. - Mismatch vendor code between adapter and expansion module.	- Use expansion slot up to 63. - Compose that IO total size is not excess. - Check status of expansion IO connection. - Check the vendor code of module.
Field Power LED turns off	- Field power is not supplied.	- Check main power Cable - Contact Sales team and send module for repair.
System Power LED turns off	- System power is not supplied.	- Check main power Cable - Contact Sales team and send module for repair.

How to diagnose when device couldn't communicate network

Inspection of wrong or omission cable connection.

- Check status of cable connection for each node.
- Check that all color matches between connector and cable.
- Check wire omission.

Terminator resistor

- If terminator resistor is not installed, install terminator resistor
- Check location of terminator resistor

Configuration of Node address

- Check duplication node address.

Configuration of Master

- Check configuration of master
- Check whether to do download or don't
- Check composition is right
 - Configuration of communication baud rate
 - I/O size
 - Configuration of each nodes

Ground and environment

- Check ground is contacted
- Check environment factor(temperature, humidity, etc) is in less than regular limit

APPENDIX A

A.1 Product List

No.	GT-Number	Description	ID(hex)
Digital Input Module			
1	GT-1238	8 Points, Universal, 24Vdc, 10RTB	1238
2	GT-123F	16 Points, Universal, 24Vdc, 20P connector	123F
3	GT-12DF	16 Points, Universal, 24Vdc, 18RTB	12DF
4	GT-12FA	32 Points, Universal, 24Vdc, 40P connector	12FA
5	GT-1804	4 Points, 120Vac, 10RTB	1804
6	GT-1904	4 Points, 240Vac, 10RTB	1904
Digital Output Module			
7	GT-2318	8 Points, Sink, 24Vdc/0.5A, 10RTB	2318
8	GT-2328	8 Points, Source, 24Vdc/0.5A, 10RTB	2328
9	GT-221F	16 Points, Sink, 24Vdc/0.3A, 20P connector	221F
10	GT-222F	16 Points, Source, 24Vdc/0.3A, 20P connector	222F
11	GT-225F	16 Points, Sink, 24Vdc/0.3A, 18RTB	225F
12	GT-226F	16 Points, Source, 24Vdc/0.3A, 18RTB	226F
13	GT-22BA	32 Points, Sink, 24Vdc/0.3A, 40P connector	22BA
14	GT-22CA	32 Points, Source, 24Vdc/0.3A, 40P connector	22CA
15	GT-2618	8 Points, Sink, 24Vdc/2A, 10RTB	2618
16	GT-2628	8 Points, Source, 24Vdc/2A, 10RTB	2628
17	GT-2734	4 Points, MOS Relay, 240Vdc/ac, 0.5A, 10RTB	2734
18	GT-2744	4 Points, Relay, 24Vdc/2A, 240Vac/2A, 10RTB	2744
19	GT-2764	4 Points, MOS Relay, 24Vdc/ac, 2A, 10RTB	2764
20	GT-2784	4 Points, MOS Relay, 110Vdc/ac, 1A, 10RTB	2784
Analog Input Module			
21	GT-3001	LoadCell (TBD)	3001
22	GT-3114	4 Channels, 0~20, 4~20mA, 12bits, 10RTB	3114
23	GT-3154	4 Channels, 0~20, 4~20mA, 16bits, 10RTB	3154
24	GT-3118	8 Channels, 0~20, 4~20mA, 12bits, 10RTB	3118
25	GT-3158	8 Channels, 0~20, 4~20mA, 16bits, 10RTB	3158
26	GT-311F	16 Channels, 0~20, 4~20mA, 12bits, 20P connector	311F
27	GT-315F	16 Channels, 0~20, 4~20mA, 16bits, 20P connector	315F
28	GT-317F	16 Channels, 0~20, 4~20mA, 12bits, 18RTB	317F
29	GT-319F	16 Channels, 0~20, 4~20mA, 16bits, 18RTB	319F
30	GT-3424	4 Channels, 0~10, 0~5, 1~5Vdc, 12bits, 10RTB	3424
31	GT-3464	4 Channels, 0~10, 0~5, 1~5Vdc, 16bits, 10RTB	3464
32	GT-3428	8 Channels, 0~10, 0~5, 1~5Vdc, 12bits, 10RTB	3428
33	GT-3468	8 Channels, 0~10, 0~5, 1~5Vdc, 16bits, 10RTB	3468
34	GT-342F	16 Channels, 0~10, 0~5, 1~5Vdc, 12bits, 20P connector	342F
35	GT-346F	16 Channels, 0~10, 0~5, 1~5Vdc, 16bits, 20P connector	346F
36	GT-347F	16 Channels, 0~10, 0~5, 1~5Vdc, 12bits, 18RTB	347F
37	GT-349F	16 Channels, 0~10, 0~5, 1~5Vdc, 16bits, 18RTB	349F

38	GT-3704	4 Channels, RTD, 10RTB	3704
39	GT-3708	8 Channels, RTD, 20P connector	3708
40	GT-3804	4 Channels, Thermocouple, 10RTB	3804
41	GT-3808	8 Channels, Thermocouple, 20P connector	3808
42	GT-3901	AC Measurement	3901
43	GT-3914	4 Channels, Differential, 0~20, 4~20, +/-20mA, 12Bits, 10RTB	3914
44	GT-3934	4 Channels, Differential, 0~20, 4~20, +/-20mA, 16Bits, 10RTB	3934
45	GT-3918	8 Channels, Differential, 0~20, 4~20, +/-20mA, 12Bits, 18RTB	3918
46	GT-3938	8 Channels, Differential, 0~20, 4~20, +/-20mA, 16Bits, 18RTB	3938
47	GT-3924	4 Channels, Differential, 0~5, 0~10, +/-5, +/-10Vdc, 12Bits, 10RTB	3924
48	GT-3944	4 Channels, Differential, 0~5, 0~10, +/-5, +/-10Vdc, 16Bits, 10RTB	3944
49	GT-3928	8 Channels, Differential, 0~5, 0~10, +/-5, +/-10Vdc, 12Bits, 18RTB	3928
50	GT-3948	8 Channels, Differential, 0~5, 0~10, +/-5, +/-10Vdc, 16Bits, 18RTB	3948
Analog Output Module			
51	GT-4114	4CH, 0~20mA, 12Bits, 10RTB	4114
52	GT-4154	4CH, 0~20mA, 16Bits, 10RTB	4154
53	GT-4118	8CH, 0~20mA, 12Bits, 10RTB	4118
54	GT-4158	8CH, 0~20mA, 16Bits, 10RTB	4158
55	GT-4424	4CH, 0~10Vdc, 12Bits, 10RTB	4424
56	GT-4464	4CH, 0~10Vdc, 16Bits, 10RTB	4464
57	GT-4428	8CH, 0~10Vdc, 12Bits, 10RTB	4428
58	GT-4468	8CH, 0~10Vdc, 16Bits, 10RTB	4468
59	GT-417F	16CH, 0~20mA, 12Bits, 18RTB	417F
60	GT-419F	16CH, 0~20mA, 16Bits, 18RTB	419F
61	GT-442F	16CH, 0~10Vdc, 12Bits, 20P Connector	442F
62	GT-446F	6CH, 0~10Vdc, 16Bits, 20P Connector	446F
63	GT-447F	16CH, 0~10Vdc, 12Bits, 18RTB	447F
64	GT-449F	16CH, 0~10Vdc, 16Bits, 18RTB	449F
Special Module			
65	GT-5102	2CH, Encoder, Input, 5Vdc, 10RTB	5102
66	GT-5211	1CH, RS 232, RTS/CTS, Full Duplex Type, 10RTB	5211
67	GT-5212	2CH, RS 232, Full Duplex Type, 10RTB	5212
68	GT-5221	1CH, RS 485, Full Duplex Type, 10RTB	5221
69	GT-5231	1CH, RS 485, Half Full Duplex Type, 10RTB	5231
70	GT-5232	2CH, RS 485, Half Full Duplex Type, 10RTB	5232
71	GT-5352	2CH, Synchronous Serial Interface Input, 10RTB	5352
72	GT-5521	1CH, Stepper Module (TBD)	5521
Power Module			
73	GT-7408	Shield Module	7408
74	GT-7508	Common for 0Vdc	7508
75	GT-7511	Power Expansion, In 24Vdc, Out 1A/5Vdc	7511
76	GT-7518	Common for 24Vdc	7518
77	GT-7588	Common for 0Vdc, 24Vdc	7588

78	GT-7641	Field Power, 5/24/48 Vdc, 110/220 Vac	7641
----	---------	---------------------------------------	------

A.2. Glossary

- System Power : The power for starting up CPU.
- Field Power : The power for input and output line.
- Terminator Resistor : Resistor for prevention reflected wave.
- EDS : Electronic Data Sheet.
- Sink : The method of in/output power supply if a device has no power source.
- Source : The method of in/output power supply if a device has the power source.



IP SYSTEMES
8 rue du Colonel Chambonnet – BP67
69672 BRON Cedex
Tel. : 04 72 14 18 00
Fax : 04 72 14 18 01
www.ip-systemes.com – info@ip-systemes.fr