

Rugged tablet EM-Q16

Instruction Manual

Thanks for your to choose the new Tablet.

This guide serves to enable users to get to know and familiar with our product as soon as possible. Here we have made a brief introduction to the key layout and definitions in figures and words. And a brief explain for the basic operating functions.

Content

1. File version information	2
2. Device performance structure	3-6
3. Device initialized setting	7
4. Desktop layout	8-9
5. System settings	10-20



IP SYSTEMES
8 rue du Colonel Chambonnet – BP67
69672 BRON Cedex
Tel. : 04 72 14 18 00
Fax : 04 72 14 18 01
www.ip-systemes.com – info@ip-systemes.fr

File Name	EM-Q16 User Manual				
File No	0001	Edition		V1.0	
Issue Date	2019-10-18	Page			
Change Log					
Serial Number	Change Number	Version	Change Date	Change Content	Maintenance Department
1	YDXX-02	V1.0	2019-10-18	Starting	Customer Service FAE Department

Please connect us if you have any question!

Device Performance Structure



1.F key —— barcode scan;

2.Power key —— Press it to turn your tablet PC on or off. Pressing with 5 seconds to turn on.Pressing with 10 seconds to turn off. Pressing with short time, for sleep mode or awaken;

3.P key —— win key;

4.Vol+ /Vol- —— raise/lower volume;

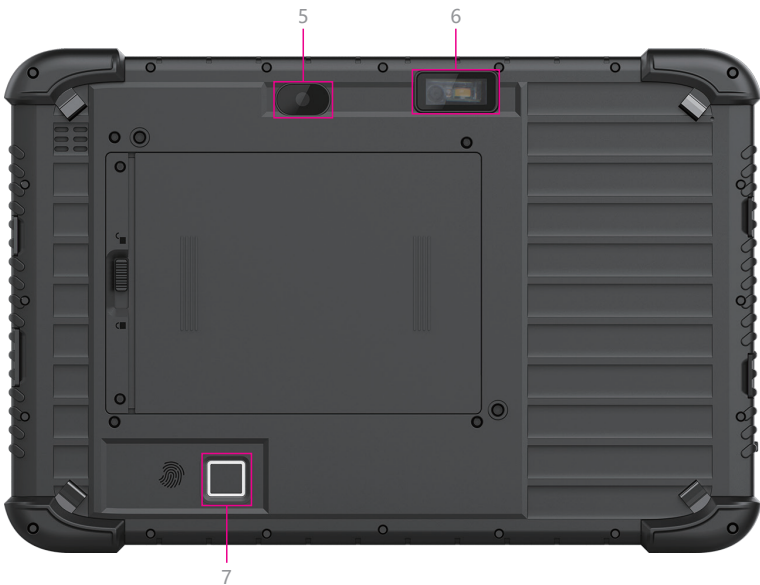

- 5. **Rear camera** — 13 million rear camera with flash, take pictures and videos;
- 6. **1D /2D module** — support one-dimensional /two-dimensional;
- 7. **Finger print** — used for log in Windows or file encryption;

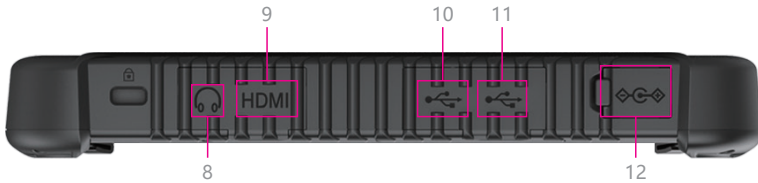

- 8. **Earphone interface** — 3.5mm standard Earphone Audio output Interface;
- 9. **HDMI interface** — High-Definition Multimedia Interface, HD media interface;
- 10. **Type C** — Data transferring, charge for the device;
- 11. **USB 3.0** — USB data transmission interface, connect USB storage devices and plug and play USB devices;
- 12. **DC jack** — DC interface charge for tablet;

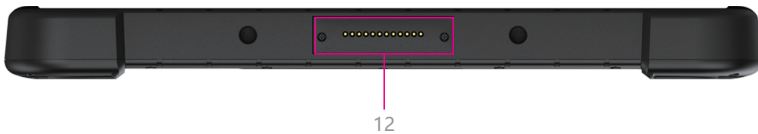

- 13. **Pogo pin** — connect docking , expand USB interface and network port / charging interface;



14.Front camera —— 5MP, take photos and record video;

15.Indicator light —— used to show the battery, the system working status and network status;

16.Light sense —— adjust automatically luminance;



17.Avigation interface —— connect electrical wiring interface(need custom-made, standard configuration machine without the interface);

18.RS232 interface —— RS232 interface, use can link other equipment or send receive data in this interface;

19.Ethernet port —— RJ45 port, user can link internet to using in this;

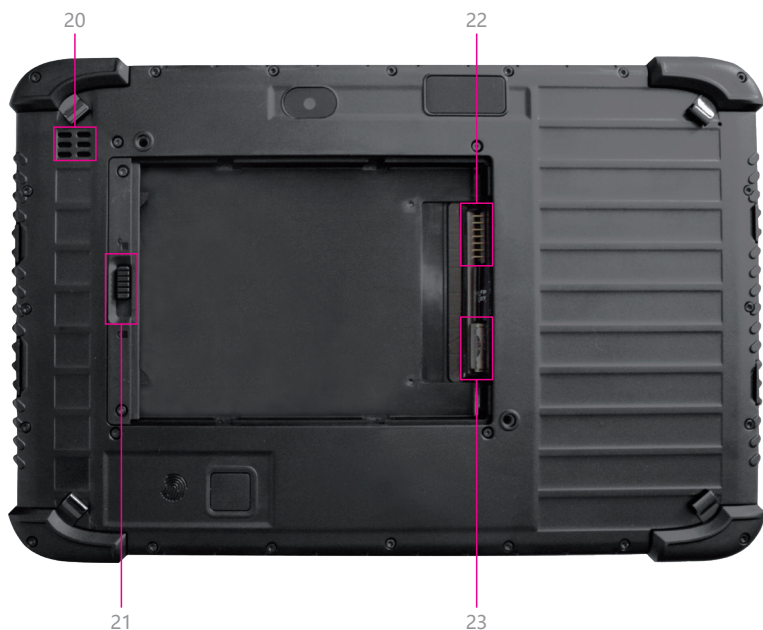

20.Speaker —— built-in speakers for video, music, 8Ω/0.8W speakers x 1;

21.Battery lock —— lock back cover protection battery;

22.Battery pin —— touch with the battery. support TF card expand, Maximum for 128G;

23.TF and SIM card —— support to 3G and 4G Network , support Nano SIM card.

Device Initialized Setting

Initial Desktop: Slide the arrow up and go to the desktop, as below picture.

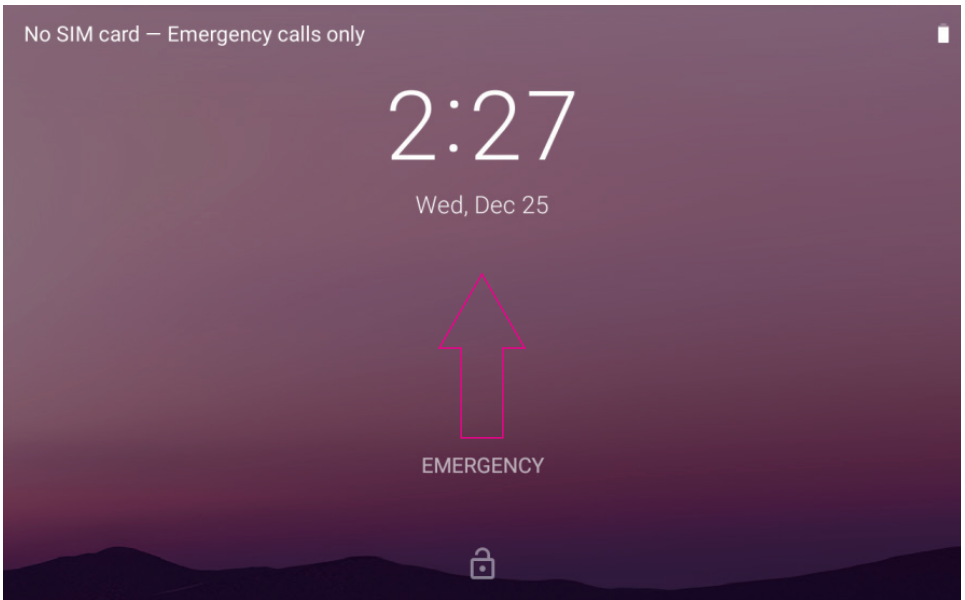

Desktop Layout

Desktop Menu Introduction: This interface can start the application in a quick way, enter the menu operation, users can add shortcuts to the desktop according to their own needs, as below picture.

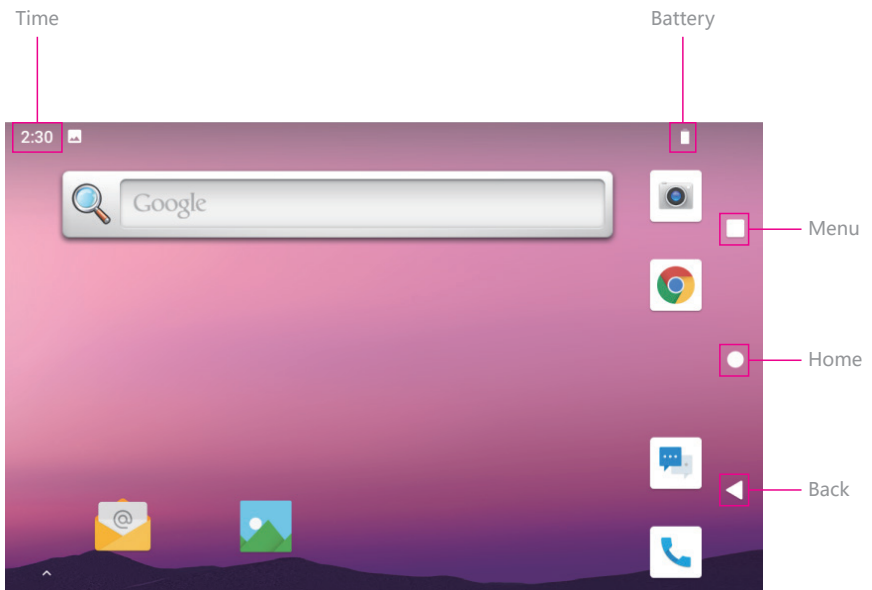

Menu Bar Layout: all the application and user installation applications are here, and all applications can be opened , as below picture.

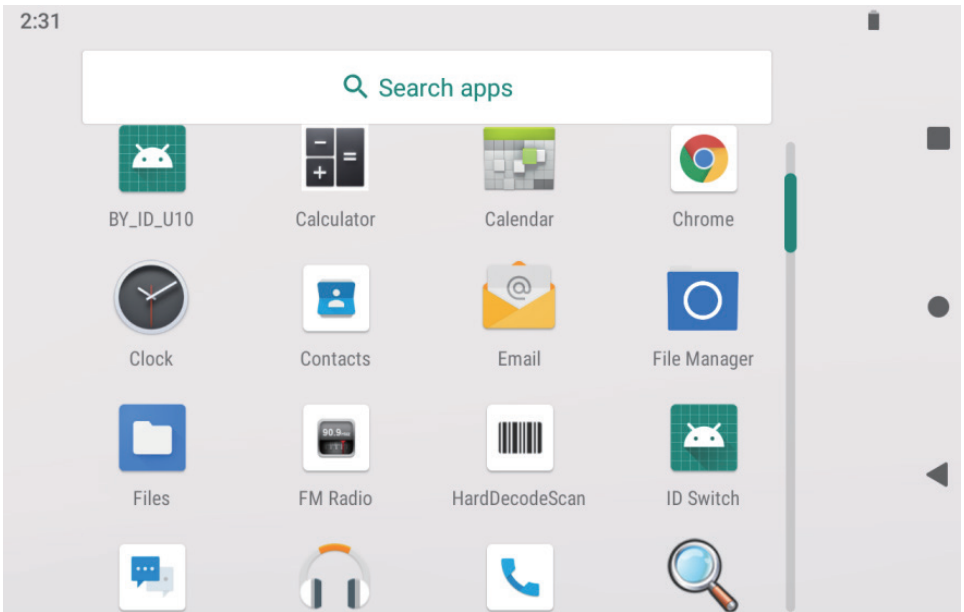

System Setting

Settings: Users can set related functions in the setting interface according to their needs, which is more convenient to use.

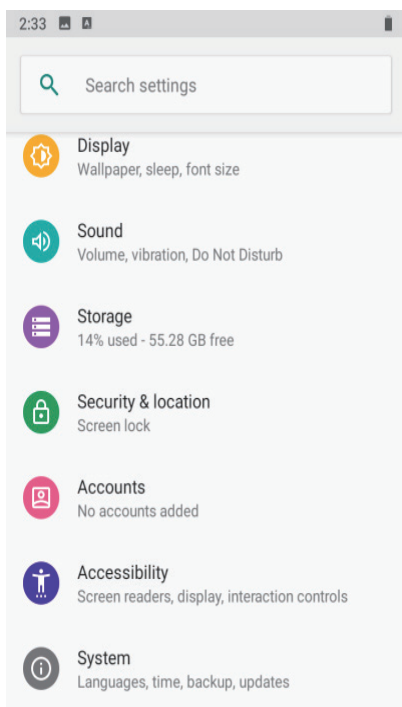
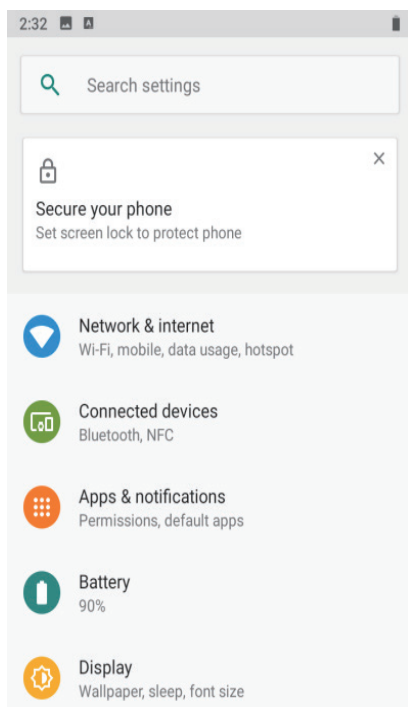

1. Screen lock settings

all the application and user installation applications are here, and all applications can be opened , as below picture.

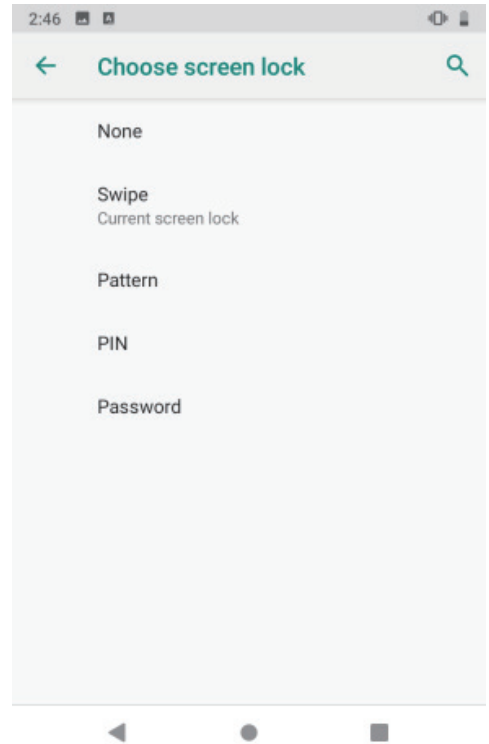

2. Network & internet

Wi-Fi: search Wi-Fi AP, input password can be connected;

Mobile network/sim card setting:

used for cellular network;

Hotspot & tethering: device work as wifi ap;

More network option can be checked on Advanced.

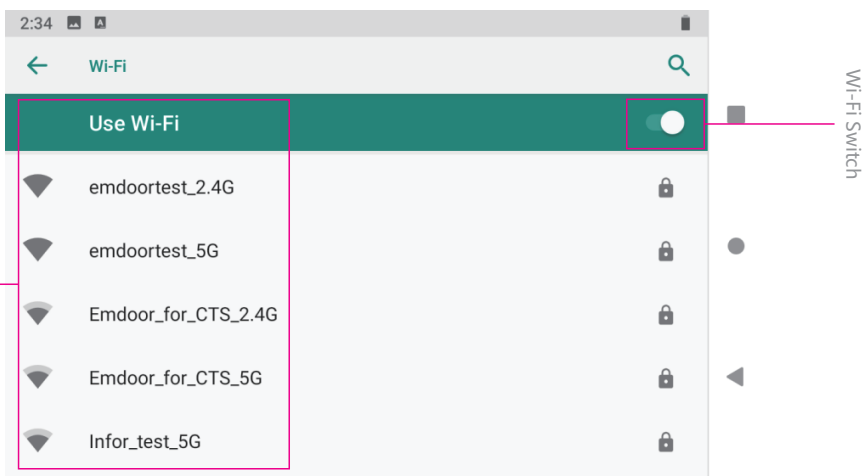
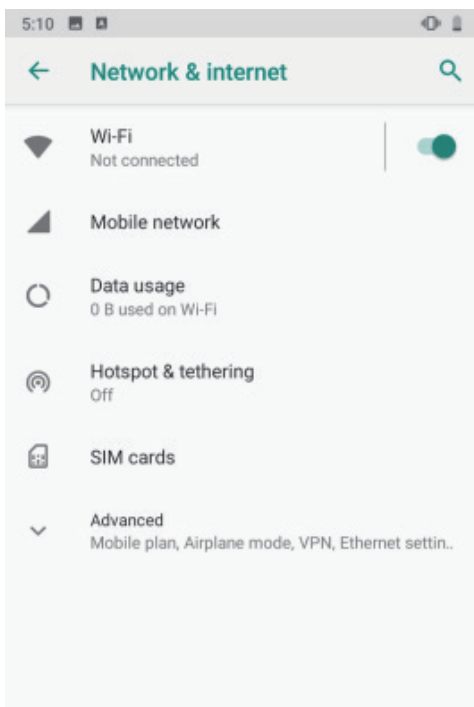

3. Connected devices: Bluetooth Setting

Search this interface for Bluetooth pairing, remove or cancel paired Bluetooth devices. As the blew picture.

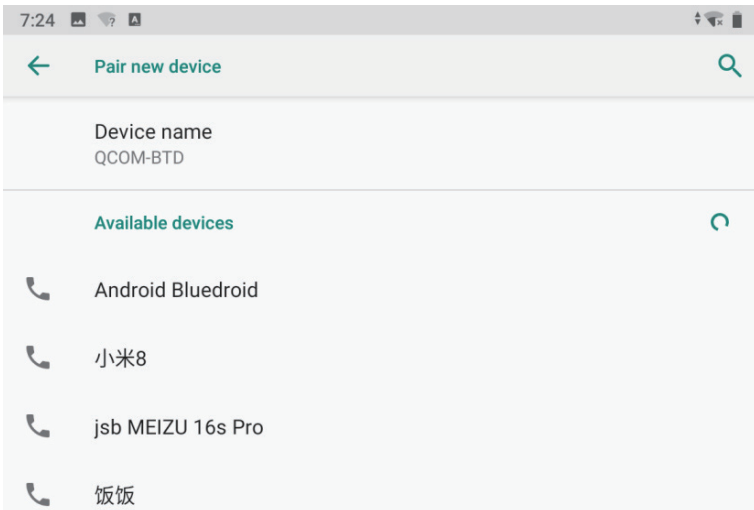
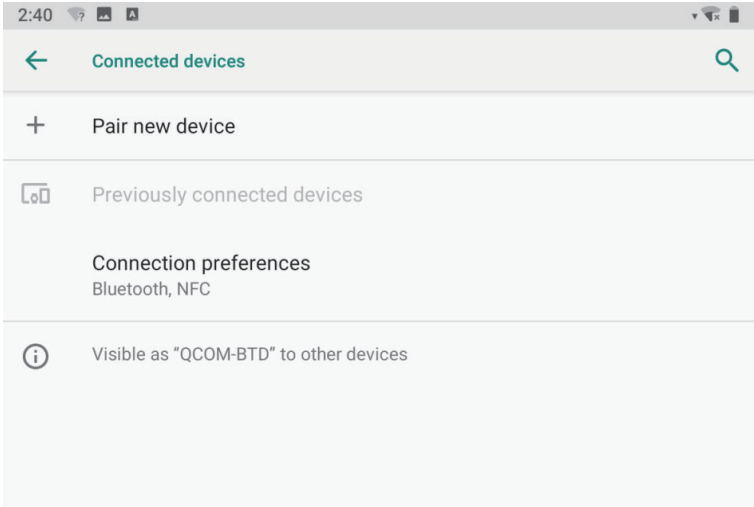

4. Apps & notifications

View installed APP storage space size, traffic usage, stop using APP. Set screen lock time, default notification prompt.

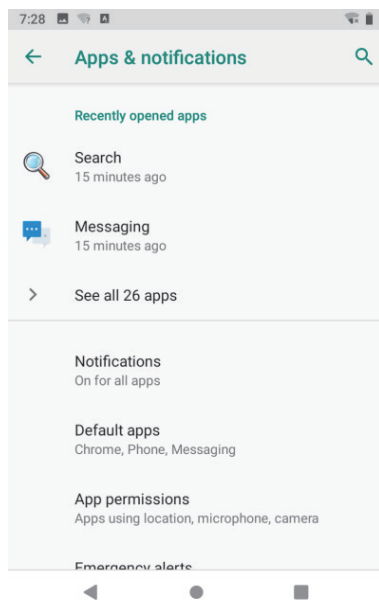

5. Battery

On this page, you can check battery power usage, open power saving mode and make some battery settings, as shown in the following figure.

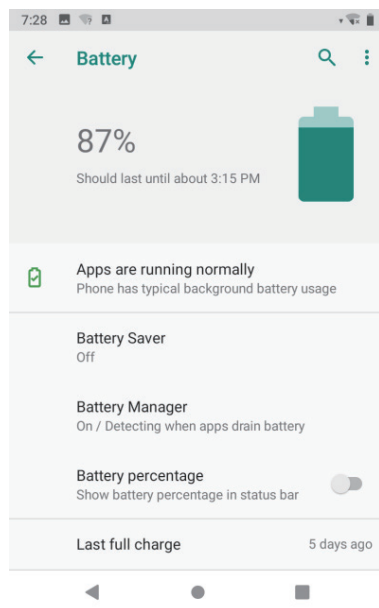

6. Display

On this page, you can set Brightness adjustment, Night light mode, wallpaper, sleep time, interactive screen saver, font size, screen rotation switch, etc.

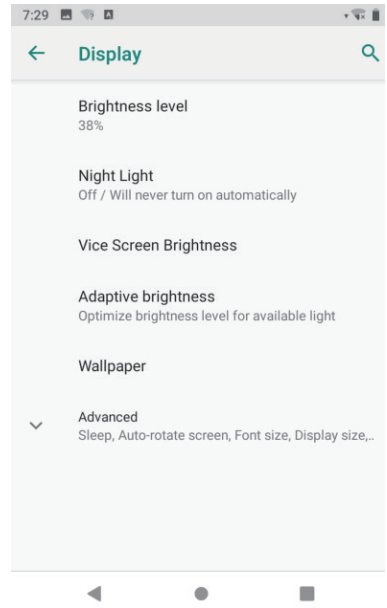

7. Sound

Set media volume, alarm volume, notify volume size (can also use physical keys to the corresponding interface directly to adjust, do not disturb settings) notification ringtone settings and other operations.

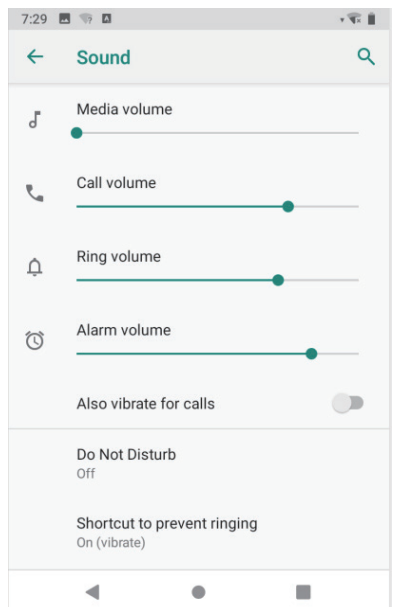

8. Storage

View system memory usage, install and uninstall SD cards.

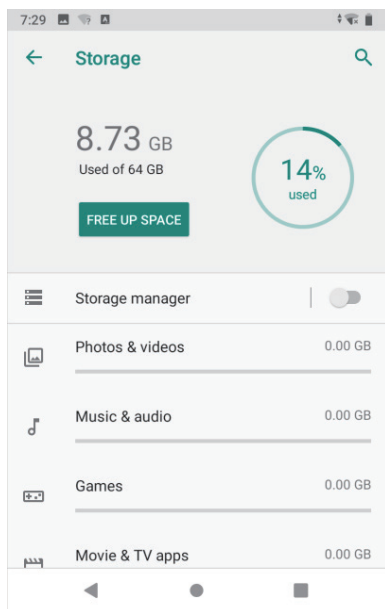

9. Security & location

Set screen locking mode with some encryption settings, can manage unknown sources of application installation settings, etc.

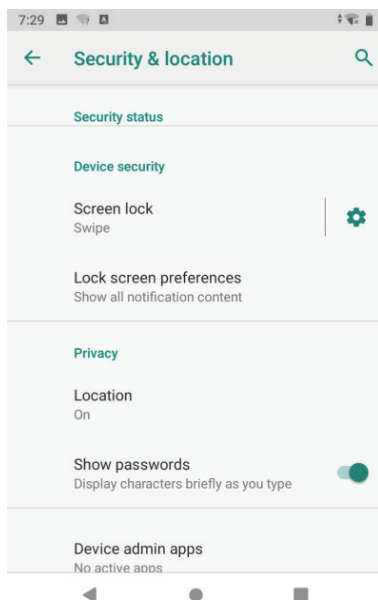

10. Accounts

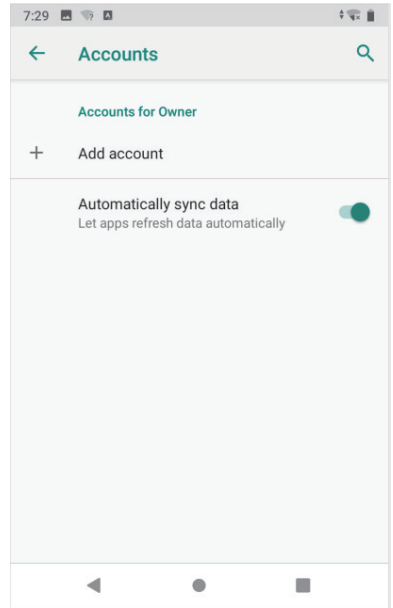

11. Accessibility

Click with accessibility, for quick settings of personal operation habits, such as: Caption, magnification gesture, front size, display size, power button ends call, auto-rotate screen, speak password, color inversion, color correction.

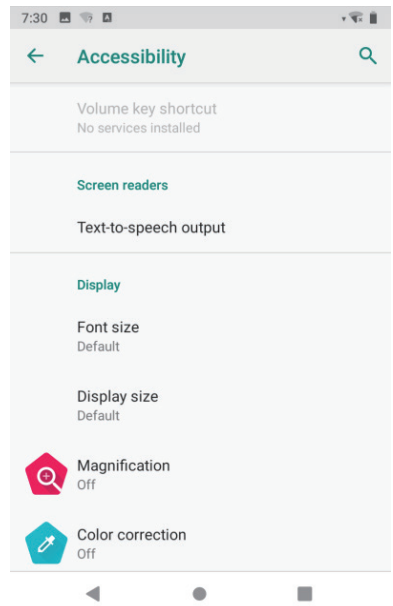

12. System

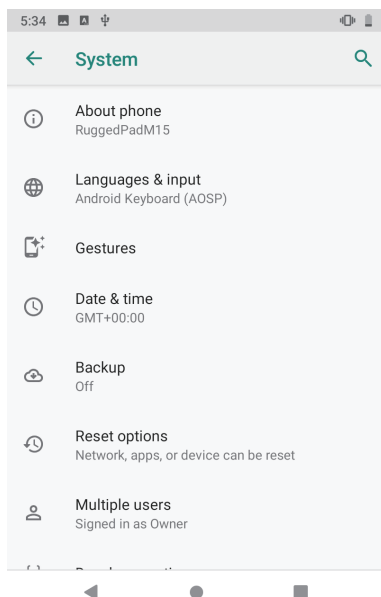

1) About Tablet

View status information, device models, Android version / Android patch level, base band version (mobile network module model), kernel version, software version number, etc.

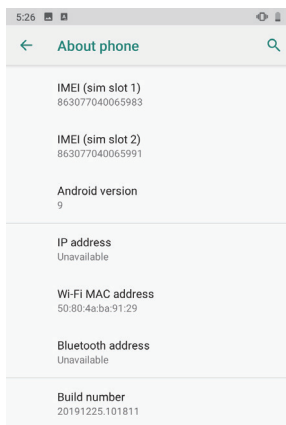
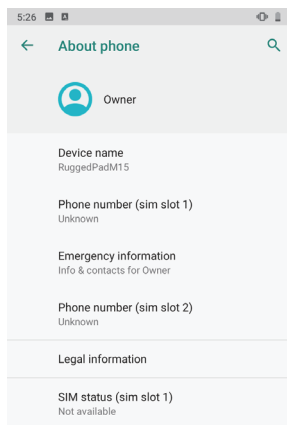

2) Languages & input

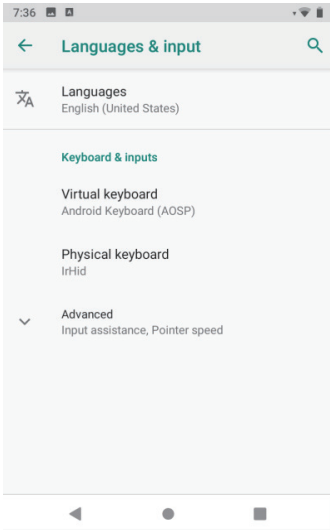

3) Gestures

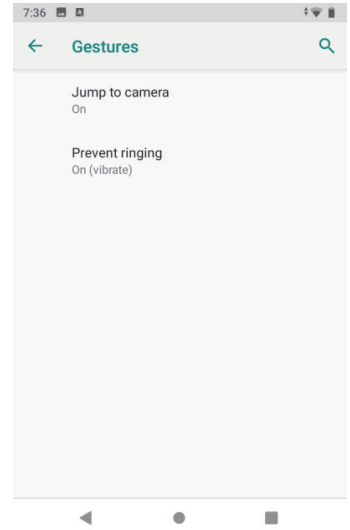

4) Date & time

Set the time and time zone and time format for 24 hours or 12 hours, or turn on automatic confirmation, which synchronizes automatically when the device is connected to the network.

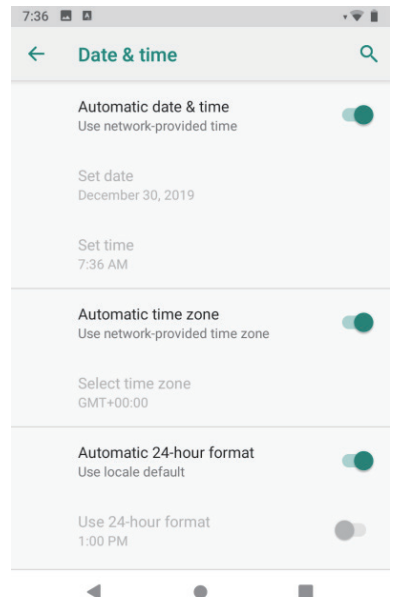

5) Backup

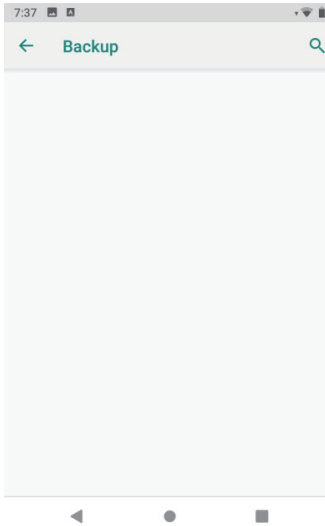

6) Reset options

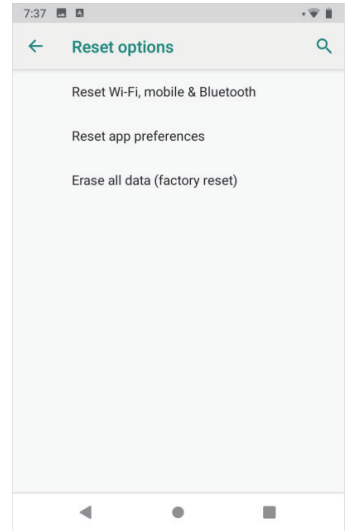

6) Multiple users

On this page, users can add or delete accounts, as shown below.

